

Varenummer: 20196B20B202SW  
 Beskrivelse: E+G Vinkelholder  
 GN 196-B20-B20-2-SW

## Mål

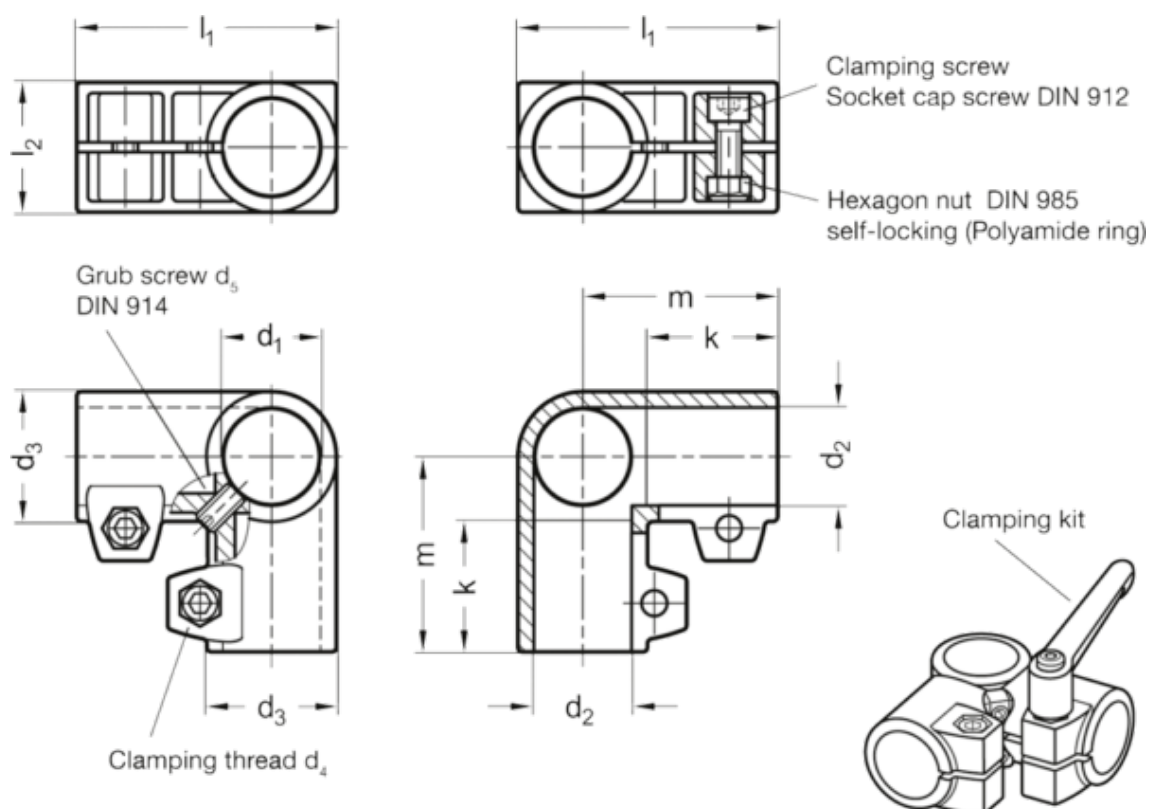

Clamping kits for  $d_4 = \text{GN 911-M8-32}$

$d_2 = \text{B 20}$

$d_3 = 40$

$d_4 = \text{M 8}$

$d_5 = \text{M 8}$

$g = 345$

$l_1 = 80$

$l_2 = 52$

$k$  Clamping length = 40

$m = 60$

Vægt i (g) = B 20